



**STARBORN®**

# GUIDE TO DECK AND TRIM FASTENING

**CLIP&RIP™  
FASCIA SYSTEM**

**PRO PLUG® SYSTEM  
DECKFAST®**

**CAP-TOR® xd  
HEADCOTE®**

**STRUCTURAL  
SMART-BIT®**



## About Us

Our goal at Starborn is to provide professional contractors, as well as, leading building materials distributors and dealers nationwide with quality construction fasteners and innovative fastening solutions that bring value to their business.

Founded in 1961, Starborn Industries originally provided wood products to the building industry, but by the early 1980's construction fasteners became our primary product line. Since the late 1990's, Starborn has focused its fastener line on deck fastening solutions. We carefully monitor the decking industry and work closely with decking manufacturers to ensure the best fastening solutions for all types of deck installations as shown by our current offering of proprietary and patented products. These include CAP-TOR® xd, DECKFAST®, PRO PLUG® SYSTEM, SMART-BIT®, and others as shown in this catalog. New product development is continuous and ongoing. Our constant goal of inventing and providing innovative fastening solutions has made Starborn a leading provider of fasteners in the decking industry worldwide. We are the deck fastening specialists.

## To Our Customers

We value your business. We value your relationship. Your success is our success. Our commitment is to continue to provide you with superior service and knowledgeable support for all of your fastener needs.

**Starborn Industries** is located in Edison, NJ and is an independent, second generation family-owned and operated business.



<b>STARBORN® Structural</b> Code Compliant Structural Wood Screws	4
<b>CLIP&amp;RIP™ Universal Hidden Deck Clip</b> Pre-assembled and Collated Hidden Deck Fasteners for PVC/Composite and Wood Decking	6
<b>DECKFAST® Epoxy</b> Color Matched Screws for Pressure Treated Lumber and PVC Trim	8
<b>DECKFAST® Stainless</b> Stainless Steel Screws for Hardwood, Cedar, Redwood and Pressure Treated Decking	10
<b>HEADCOTE® Stainless</b> Stainless Steel Screws With Color Coated Heads for Hardwood, Cedar, Redwood, Pressure Treated Decking, PVC Trim and Deck Fascia	12
<b>CAP-TOR® xd Epoxy/Stainless</b> Color Matched Screws for Composite and PVC Decking and Cladding	14
<b>CAP-TOR® xd Metal</b> Color Matched Screws for Composite/PVC Decking and Cladding to Metal Framing	16
<b>FASCIA SYSTEM Epoxy/Stainless</b> Composite Fascia Board and Cladding	18
<b>PRO PLUG® SYSTEM Deck</b> Hidden Fastener for PVC/Composite Decking and Cladding	20
<b>PRO PLUG® SYSTEM Trim</b> Hidden Fastener for PVC Trim Board	22
<b>PRO PLUG® SYSTEM Fascia</b> Hidden Fastener for Composite Fascia Board and Cladding	24
<b>PRO PLUG® SYSTEM Wood</b> Hidden Fastener for Wood Decking and Flooring	26
<b>SMART-BIT® Predrilling and Countersinking Tool</b> For use with HEADCOTE® and DECKFAST® Stainless Screws	28
<b>SMART-BIT® Depth Setter Tool</b> Driving Tool for Setting Screws to the Perfect Depth	30

# STARBORN<sup>®</sup> STRUCTURAL

## Code Compliant Wood Screws



### APPLICATION

Starborn<sup>®</sup> Structural screws are fully tested and code compliant alternatives to traditional lag screws and through-bolts, with no predrilling required. Designed to save time and reduce labor, these structural screws can be used in a variety of applications including deck ledgers, deck substructures, landscape timbers, fences, pergolas, carrying beams, timber frames and more.

### FEATURES

- IRC/IBC code compliant (DrJ TER 1703-05)
- No predrilling
- Superior design values and performance
- Speed-Knurl™ reduces friction for faster installation
- Tri-Forge<sup>®</sup> Point allows for fast start and reduces driving torque

### INSTALLATION

- Starborn<sup>®</sup> Structural screws should be installed using an impact driver or high-torque low speed drill.
- Predrilling is not required, but can be used where lumber is prone to splitting.
- For the H19 screw drive until washer head is flush to wood surface or countersink head flush.
- For the F19, H23, and F23 screws drive until washer is drawn firm and flush. Do not overdrive or countersink

### FINISH

Black exterior coating

### CORROSION

Black exterior coating: H19, F19, H23 and F23 | Approved for use in ACQ and pressure treated lumber.

Starborn<sup>®</sup> Structural screws are not designed for use in or near saltwater environments.

### DRIVE SYSTEM

Hex Head  
Star drive

### TECHNICAL GUIDES

TECHNICAL GUIDE	PRODUCT	
Deck Ledger to Rim Joist	H23	F23
Ledger to Stud with 0, 1, or 2 Layers of 5/8" Gypsum	H23	F23
Truss or Rafter to Top Plate	H19	
Multi-Ply Dimensional Wood Connections	F19	F23
Cladding Over Foam Sheathing	F19	F23
Bottom Plate to Rim Board	H19	
Screw Properties and Design Values	All	

For more information including technical guides and code compliance reports, visit [starbornindustries.com](http://starbornindustries.com).

## STARBORN® STRUCTURAL

### DESIGN FEATURES

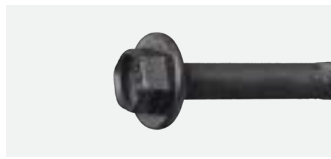

**Hex Head**  
For maximum driveability



**Low Profile Flat Head**  
Star drives eliminate cam-out

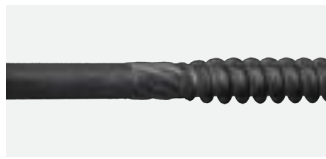

**Speed-Knurl™**  
Reduces friction for faster installation

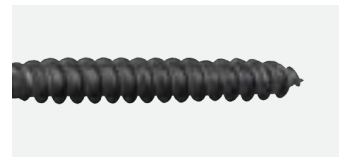

**Tri-Forge® Point**  
Fast start, minimal splitting, reduced driving torque

### STARBORN® STRUCTURAL PACKAGING H19



LENGTH	20 PC		50 PC		250 PC	500 PC
	ITEM NO	CASE QTY	ITEM NO	CASE QTY	ITEM NO	ITEM NO
2-7/8"	XH19CL0288	6	XH19CT0288	6	XH19CQ0288	XH19CV0288
4"	XH19CL0400	6	XH19CT0400	6	XH19CQ0400	XH19CV0400
6"	XH19CL0600	6	XH19CT0600	6	XH19CQ0600	XH19CV0600
8"	XH19CL0800	6	XH19CT0800	3	XH19CQ0800	—
10"	XH19CL1000	6	XH19CT1000	3	XH19CQ1000 (200PC)	—

### STARBORN® STRUCTURAL PACKAGING H23



LENGTH	20 PC		50 PC		250 PC	500 PC
	ITEM NO	CASE QTY	ITEM NO	CASE QTY	ITEM NO	ITEM NO
4"	XH23CL0400	6	XH23CT0400	6	XH23CQ0400	XH23CV0400
5"	XH23CL0500	6	XH23CT0500	6	XH23CQ0500	XH23CV0500

### STARBORN® STRUCTURAL PACKAGING F19



LENGTH	20 PC		50 PC		250 PC	500 PC
	ITEM NO	CASE QTY	ITEM NO	CASE QTY	ITEM NO	ITEM NO
2-7/8"	XF19CL0288	6	XF19CT0288	6	XF19CQ0288	XF19CV0288
4-1/2"	XF19CL0450	6	XF19CT0450	6	XF19CQ0450	XF19CV0450
6"	XF19CL0600	6	XF19CT0600	6	XF19CQ0600	XF19CV0600
8"	XF19CL0800	6	XF19CT0800	3	XF19CQ0800	—
10"	XF19CL1000	6	XF19CT1000	3	XF19CQ1000 (200PC)	—
12"	XF19CL1200	5	—	—	XF19CQ1200 (200PC)	—
14"	XF19CL1400	5	—	—	XF19CQ1400 (200PC)	—
16"	XF19CL1600	5	—	—	XF19CQ1600 (150PC)	—

### STARBORN® STRUCTURAL PACKAGING F23



LENGTH	20 PC		50 PC		250 PC	500 PC
	ITEM NO	CASE QTY	ITEM NO	CASE QTY	ITEM NO	ITEM NO
2-7/8"	XF23CL0288	6	XF23CT0288	6	XF23CQ0288	XF23CV0288
4"	XF23CL0400	6	XF23CT0400	6	XF23CQ0400	XF23CV0400
5"	XF23CL0500	6	XF23CT0500	6	XF23CQ0500	XF23CV0500
6"	XF23CL0600	6	XF23CT0600	6	XF23CQ0600	XF23CV0600
8"	XF23CL0800	6	XF23CT0800	3	XF23CQ0800	—
10"	XF23CL1000	6	XF23CT1000	3	XF23CQ1000 (200PC)	—



# Clip&Rip™

## Universal Hidden Deck Clip

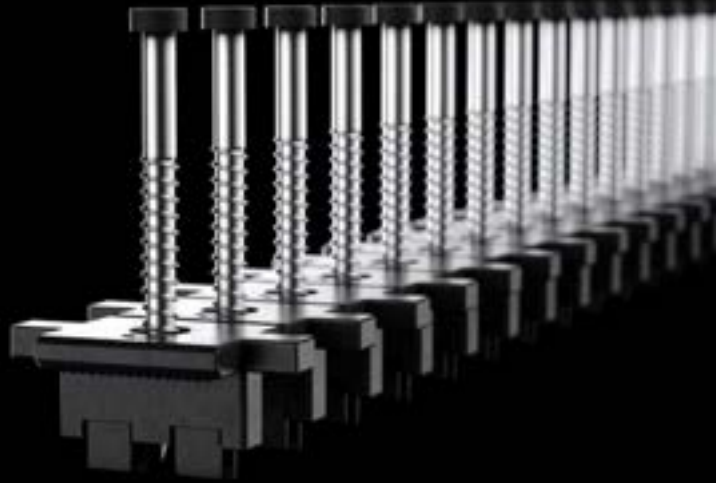

### APPLICATION

Clip&Rip™ universal hidden deck fasteners secure inner decking boards quickly and effectively while maintaining a clean, fastener-free finish. Clip&Rip™ comes pre-loaded with stainless steel screws and assembled in ready-to-install strips saving time and money.

### FEATURES

- For use with grooved composite, PVC and wood decking in any deck pattern.
- Pre-assembled in collated “sticks” of 16 for increased installation speed and ease of use.
- Clip creates 3/16” spacing between boards
- 305 and 316 stainless steel screw options available
- T15 driver bit included

### INSTRUCTIONS

- Insert the strip of clips with the  arrow pointing forward into the leading board groove. Center over joist.
- Drive the screw down in a straight and steady fashion until the head of the screw is flush with the clip.
- Lift up on strip to break off installed clip.
- Install clips at every joist along length of board.
- Place next board into position. Holding the deck board at a slight angle, push deck board into previously installed clips. Check gapping between boards to ensure consistency.

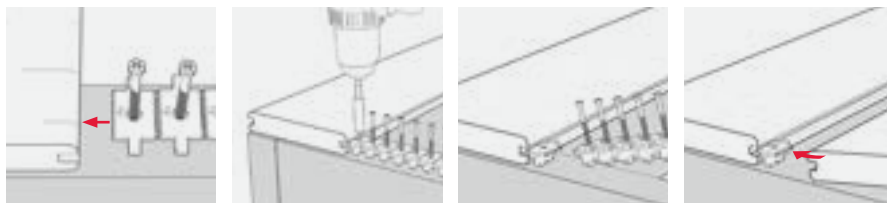

### ESTIMATED COVERAGE

JOIST SPACING	100 SQ. FT. (AREA)	200 SQ. FT. (AREA)	300 SQ. FT. (AREA)	400 SQ. FT. (AREA)	500 SQ. FT. (AREA)
12"	210	441	672	882	1113
16"	175	336	512	672	848

### BOARD COMPATIBILITY

Clip&Rip™ works with most brands of grooved PVC and Composite deck boards, including Trex®, Timbertech®, Fiberon®, MoistureShield® and more. It also works with most styles of 5/4 hardwood and thermally modified deck boards.

### FINISH

#### Starter Clips

- 305 Stainless Starter Clip

#### Field Clips

- Glass Filled Nylon Field Clips
- 305 and 316 Stainless screw options

### CORROSION

Exterior use—Approved for use in ACQ and pressure treated lumber.

For salt water or other areas where corrosion is a concern, use Grade 316 Stainless.

### DRIVE SYSTEM

T15 Star Drive

**COMPATIBLE PVC/COMPOSITE BOARDS**

<b>TREX®</b> SELECT TRANSCEND TRANSCEND LINEAGE SIGNATURE ENHANCE	<b>TIMBERTECH®</b> LEGACY RESERVE PRIME PRIME+ TERRAIN (AZEK) HARVEST (AZEK) LANDMARK (AZEK) VINTAGE	<b>FIBERON®</b> PARAMOUNT PROMENADE GOODLIFE CONCORDIA SANCTUARY	<b>DECKORATORS®</b> PICTURE FRAME VENTURE VAULT VISTA VOYAGE TRAILHEAD TROPICS (LOWES) DISTRESSED (LOWES)	<b>MOISTURESHIELD®</b> VISION MERIDIAN ELEVATE VANTAGE
<b>ARMADILLO®</b> COMMERCIAL LIFESTYLE ESSENTIAL HERITAGE	<b>WOLF</b> PERSPECTIVE	<b>EVALAST®</b> APEX INFINITY	<b>ENVISION®</b> DISTINCTION EXPRESSION EVERGRAIN RIDGE PREMIUM	<b>NEWTECH WOOD®</b> MAGELLAN VOYAGER
<b>SYLVANIX®</b> ELEMENTS DESTINATIONS ELITE ESSENTIALS ELITE COLLECTION SKYLINE	<b>TRUNORTH CLUBHOUSE®</b> ULTRA LEGACY	<b>VERANDA®</b> ELITE HIGH-PERFORMANCE	<b>VEKADECK®</b> GROOVE	

**SYSTEM COMPONENTS**

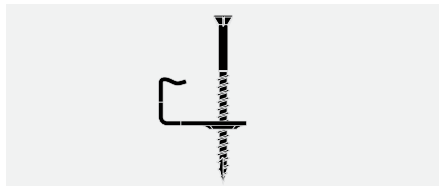

**Starter Clip**

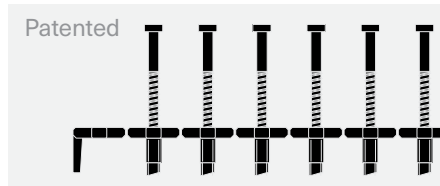

**Clip&Rip Strip**

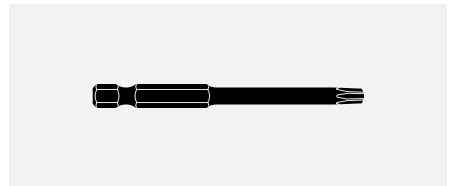

**T15 BIT**

**CLIP&RIP™ STRIP PACKAGING**



LENGTH	ITEM NO	FINISH	DRIVE TYPE	CLIPS PER STRIP	PACK QTY
1-3/4"	KAS38T175	305 Stainless with Nylon Clip	T15	16	192 (12 strips)
	KAU38T175	316 Stainless with Nylon Clip			192 (12 strips)
	KAS38B175	305 Stainless with Nylon Clip			800 (50 strips)
	KAU38B175	316 Stainless with Nylon Clip			800 (50 strips)

**CLIP&RIP™ STARTER CLIP PACKAGING**

LENGTH	ITEM NO	FINISH	DRIVE TYPE	PACK QTY
1-5/8"	KBS01A162	305 Stainless with Stainless Clip	T15	12 strips



**STARTER CLIP INSTRUCTIONS**

- For first and last boards, screw a starter clip at every joist.
- Once all starter clips are installed, push the first deck board into the starter clips.
- Proceed to fasten remainder of boards with standard clips.

\*Starter clips are only available in 305 stainless steel

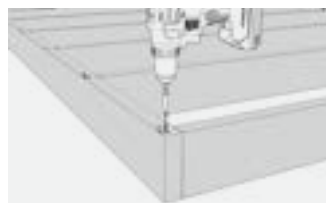

# DECKFAST®

## Epoxy

### Exterior Wood Screw



#### APPLICATION

Color Matched Screws for Pressure Treated Lumber and PVC Trim.

- Flat Head—For use in pressure treated decking.
- Trim Head—For use in pressure treated trim and finish applications.

#### FEATURES

- For excellent corrosion resistance and color matching with various types of treated lumber and PVC trim (Gray, Green, Red, Tan, White)
- Lengths from 1-1/4" to 6"
- Reinforced flat or trim head with nibs for better countersinking
- Extra deep star drive recesses to prevent cam-out
- Type 17 auger tip for faster, easier insertion and to help prevent splitting

#### INSTALLATION

- Install flush with decking surface. Do not overdrive.
- Install two screws per joist.
- Predrilling is recommended when fastening within 1-1/2" from the end of a deck board.

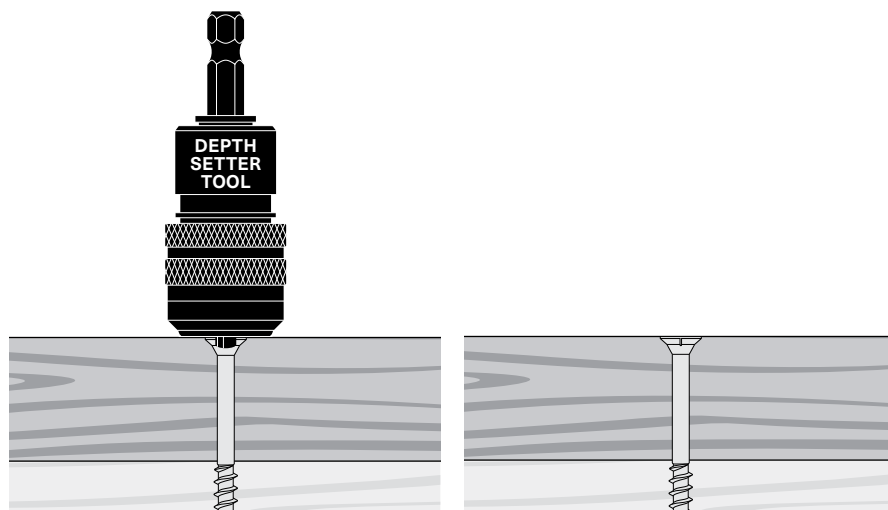

#### FINISH

Epoxy Coated

#### CORROSION

Exterior use—Approved for use in ACQ and pressure treated lumber.

For salt water or other areas where corrosion is a concern, use Grade 316 Stainless.

#### DRIVE SYSTEM

Star drive

#### TOOL COMPATIBILITY

SMART-BIT® Depth Setter Tool



**AVAILABLE COLORS**



GRAY #57    GREEN #91    RED #84    TAN #62    WHITE #39\*

\*White (#39) available only in Trim Head—2" and 2-1/2" lengths

**FLAT HEAD PACKAGING**



LENGTH	DRIVE TYPE	COUNT PACKAGING			POUND PACKAGING		
		RETAIL PACKS	JOB PACKS	BULK	1 LB	5 LBS	9 LBS
1-1/4"	T20	100	500	8000	•	•	•
1-5/8"		100	500	5000	•	•	•
2"		100	500	3500	•	•	•
2-1/2"	T25	75	250	2500	•	•	•
3"		75	250	2000	•	•	•
3-1/2"		50	250	1000	•	•	•
4"		50	250	1000	•	•	•
5"		30	—	500	•	—	•
6"		30	—	500	•	—	•

**TRIM HEAD PACKAGING**



LENGTH	DRIVE TYPE	COUNT PACKAGING			POUND PACKAGING		
		RETAIL PACKS	JOB PACKS	BULK	1 LB	5 LBS	9 LBS
1-5/8"	T20	100	500	5000	•	•	•
2"		100	500	3500	•	•	•
2-1/2"		75	250	2500	•	•	•
3"		75	250	2000	•	•	•
3-1/2"		50	250	1000	•	•	•
4"		50	250	1000	•	•	•

# DECKFAST®

## Stainless

### Exterior Wood Screw



#### APPLICATION

Stainless steel screws for hardwood, cedar, redwood and pressure treated decking.

- Flat Head—For hardwood, cedar, redwood and pressure treated decking.
- Trim Head—For hardwood, cedar and redwood; pressure treated trim and finish applications.

#### FEATURES

- Grade 305 and Grade 316 stainless steel for superior corrosion resistance
- Lengths from 1-1/4" to 3-1/2"
- Reinforced flat or trim head with nibs for better countersinking
- Extra deep star drive recesses to prevent cam-out
- Type 17 auger tips for faster, easier insertion and to help prevent splitting

#### INSTALLATION

- Predrilling required for hardwoods and in all cases when fastening within 1-1/2" from the end of a deck board.
- Slightly countersink screw head. Do not overdrive.
- Recommended: For a clean and professional finish use SMART-BIT® Predrilling and Countersinking Tools in combination with screws.

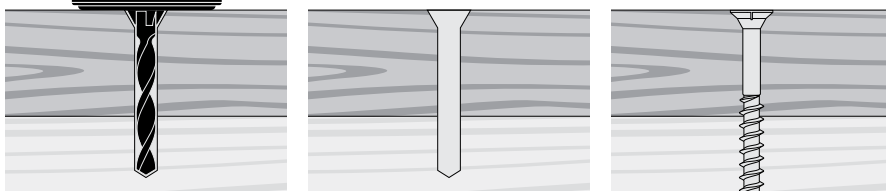
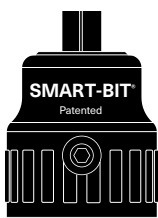

#### FINISH

Grade 305 Stainless  
Grade 316 Stainless

#### CORROSION

Exterior use—Approved for use in ACQ and pressure treated lumber.

For salt water or other areas where corrosion is a concern, use Grade 316 Stainless.

#### DRIVE SYSTEM

Star drive

#### TOOL COMPATIBILITY

SMART-BIT® Predrilling and Countersinking Tool  
SMART-BIT® Depth Setter Tool



**FLAT HEAD PACKAGING**



LENGTH	DRIVE TYPE	COUNT PACKAGING			POUND PACKAGING		
		RETAIL PACKS	JOB PACKS	BULK	1 LB	5 LBS	9 LBS
6 x 1-1/4"	T20	100	500	5000	•	•	•
8 x 1-5/8"		100	500	4000	•	•	•
8 x 2"		100	500	3000	•	•	•
10 x 2-1/2"	T25	75	250	2000	•	•	•
10 x 3"		75	250	1500	•	•	•
10 x 3-1/2"		50	250	1000	•	•	•

**TRIM HEAD PACKAGING**



LENGTH	DRIVE TYPE	COUNT PACKAGING			POUND PACKAGING		
		RETAIL PACKS	JOB PACKS	BULK	1 LB	5 LBS	9 LBS
7 x 1-5/8"	T15	100	500	5000	•	•	•
7 x 2-1/4"		75	250	3000	•	•	•
8 x 2-1/2"	T20	75	250	2500	•	•	•
8 x 3"		75	250	2000	•	•	•

# HEADCOTE®

## Stainless

### Deck Screws



#### APPLICATION

Stainless steel screws with color coated heads for hardwood, cedar, redwood, pressure treated decking, PVC fascia and trim boards.

- Flat Head—For hardwood, cedar, redwood, composite/PVC and pressure treated decking.
- Trim Head—For hardwood, cedar, redwood, composite/PVC, pressure treated decking (finish applications) and PVC trim.

#### FEATURES

- Grade 305 and Grade 316 stainless steel for superior corrosion resistance
- Lengths from 1-5/8" to 3"
- Reinforced flat or trim head with nibs for better countersinking
- Extra deep star drive recesses to prevent cam-out
- Type 17 auger tips for faster, easier insertion and to help prevent splitting
- Approved for use in ACQ and other pressure treated lumber

#### INSTALLATION

- Predrilling required for hardwoods and in all cases when fastening within 1-1/2" from the end of a deck board.
- Slightly countersink screw head. Do not overdrive.
- Recommended: For a clean and professional finish use SMART-BIT® Predrilling and Countersinking Tools in combination with screws.

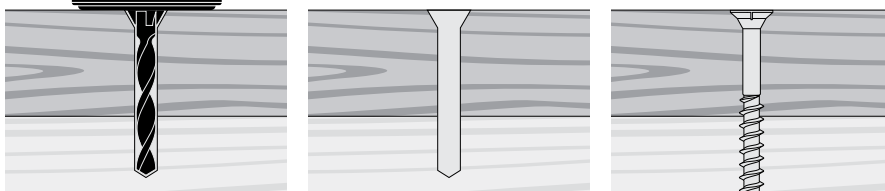
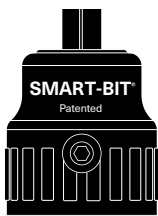

#### FINISH

Grade 305 Stainless  
Grade 316 Stainless

#### CORROSION

Exterior use—Approved for use in ACQ and pressure treated lumber.

For salt water or other areas where corrosion is a concern, use Grade 316 Stainless.

#### DRIVE SYSTEM

Star drive

#### TOOL COMPATIBILITY

SMART-BIT® Depth Setter Tool  
SMART-BIT® Predrilling and Countersinking Tool

AVAILABLE COLORS



HEADCOTE® COLORS TRIM

LENGTH	AVAILABLE COLORS
	305 STAINLESS
7 x 1-5/8"	31, 34, 37, 38, 39, 43, 45, 53, 54, 63, 64, 65, 71, 73, 81, 82
7 x 2-1/4"	34, 37, 38, 39
8 x 2-1/2"	31, 34, 37, 39, 54, 55, 64, 65, 71, 73, 81, 82, 87
8 x 3"	31, 34, 37
LENGTH	316 STAINLESS
7 x 1-5/8"	34, 39, 54
8 x 2-1/2"	34, 39, 54

HEADCOTE® COLORS FLAT

LENGTH	AVAILABLE COLORS
	305 STAINLESS
8 x 2"	34, 37
10 x 2-1/2"	31, 34, 37
10 x 3"	

FLAT HEAD PACKAGING



LENGTH	DRIVE TYPE	COUNT PACKAGING				
		RETAIL PACK	DECK PACK	CONTRACTOR PACK	PRO PACK	BULK
2"	T20	100	350	1050	—	3000
2-1/2"	T25	100	250	1050	1750	2000
3"		85	265	1050	1750	1500

TRIM HEAD PACKAGING



LENGTH	DRIVE TYPE	COUNT PACKAGING				
		RETAIL PACK	DECK PACK	CONTRACTOR PACK	PRO PACK	BULK
1-5/8"	T15	100	350	1050	—	5000
2-1/4"		100	350	—	—	3000
2-1/2"	T20	100	350	1050	1750	2500 (305 SS Only)
3"		—	350	1050	1750	2000

# CAP-TOR<sup>®</sup> xd

## Epoxy/Stainless

### Composite/PVC Deck Screws



#### APPLICATION

Color matched deck screw available in a variety of colors to match all of the leading composite/PVC deck boards and cladding on the market.

#### FEATURES

- Extra deep star drive recess to prevent cam-out
- Undercut head to cut cleanly through the hard outer layer of capstock decking
- Reverse threads to prevent mushrooming and surface defects
- Tri-lobular shanks and thread to reduce driving torque
- Type 17 auger tips for faster, easier insertion and to help prevent splitting
- Available in a variety of colors

#### INSTALLATION

- Install flush with decking surface. Do not overdrive.
- Install two screws per joist.
- Predrilling is recommended when fastening within 1" from the end of a deck board.
- Recommended: For a clean and professional finish use the SMART-BIT<sup>®</sup> Depth Setter Tool in combination with screws.

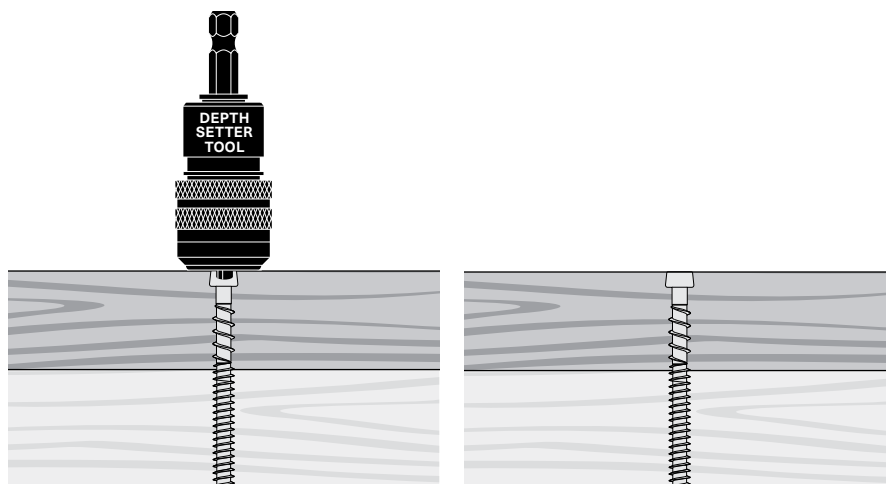

#### FINISH

Epoxy coated  
Grade 305 Stainless  
Grade 316 Stainless

#### CORROSION

Exterior use—Approved for use in ACQ and pressure treated lumber.  
  
For salt water or other areas where corrosion is a concern, use Grade 316 Stainless.

#### DRIVE SYSTEM

Star drive

#### TOOL COMPATIBILITY

SMART-BIT<sup>®</sup> Depth Setter Tool



**AVAILABLE COLORS**

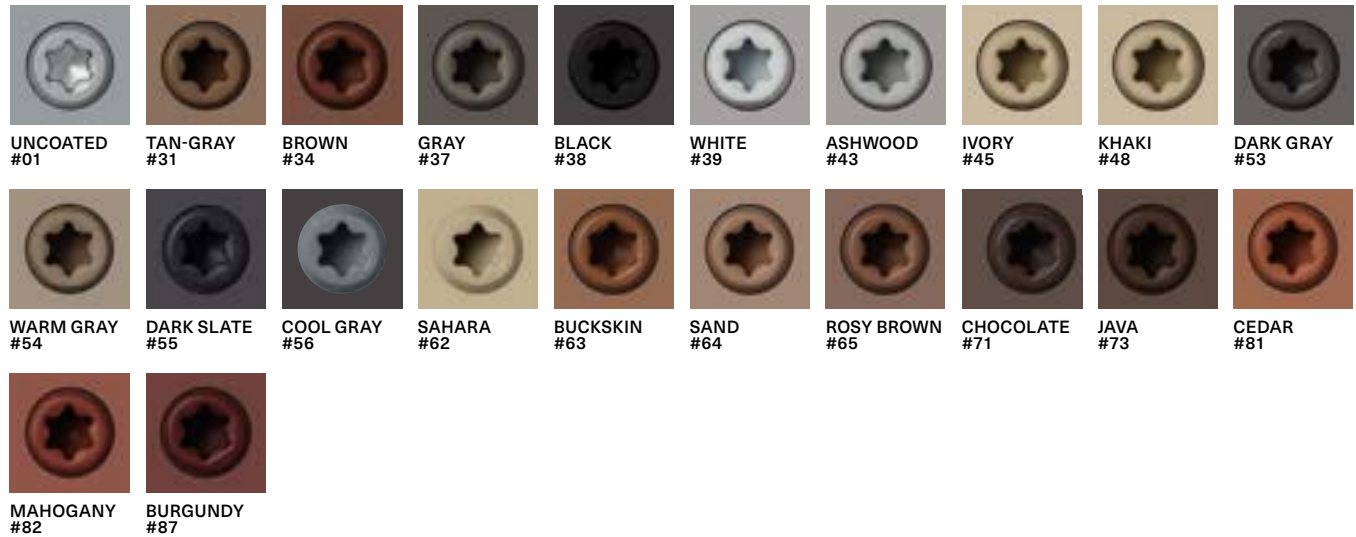

**CAP-TOR® XD COLORS**

LENGTH	AVAILABLE COLORS	
	EPOXY	
10 x 2"	34, 37, 38, 43, 53, 54, 55, 56, 62, 64, 65, 71, 73, 81, 87	
10 x 2-3/4"	31, 34, 37, 38, 43, 53, 54, 55, 56, 62, 63, 64, 65, 71, 73, 81, 82, 87	
LENGTH	305 STAINLESS	
10 x 2"	01	34, 37, 43, 53, 54, 55, 64, 65, 71, 73, 81, 87
10 x 2-1/2"		31, 34, 37, 38, 39, 43, 45, 53, 54, 55, 56, 62, 63, 64, 65, 71, 73, 81, 82, 87
10 x 2-3/4"	—	31, 34, 37, 38, 39, 43, 45, 48, 53, 54, 55, 63, 64, 65, 71, 73, 81, 82, 87
LENGTH	316 STAINLESS	
10 x 2-1/2"	01	31, 34, 37, 38, 39, 43, 53, 54, 55, 56, 62, 63, 64, 65, 71, 73, 81, 82
10 x 2-3/4"		31, 34, 37, 38, 39, 43, 45, 53, 54, 55, 63, 64, 65, 71, 73, 81, 82, 87

**CAP-TOR® XD PACKAGING**



LENGTH	FINISH	DRIVE TYPE	COUNT PACKAGING			
			RETAIL PACK	DECK PACK	CONTRACTOR PACK	PRO PACK
2"	Epoxy	T20	100	350	—	1750
2-3/4"						
2"	305 Stainless		100	350	1050	1750
2-1/2"						
2-3/4"	316 Stainless		100	350	1050	1750
2-1/2"						
2-3/4"						

# CAP-TOR<sup>®</sup> xd

## Metal

Composite/PVC

Deck Screw For Metal Framing



### APPLICATION

Color matched screws for attaching composite/PVC decking and cladding to steel or aluminum framing.

- 10 x 1-1/2": 3/4" to 1" decking material attached to 16–20 gauge joists or furring.
- 10 x 1-5/8": 3/4" to 1" decking material attached to 12–18 gauge joists or two 14 gauge joists doubled up.
- 12 x 2-3/8": 1" to 1-1/2" decking material attached to up to 1/4" thick joists.

### FEATURES

- Epoxy coated Grade 410 stainless steel
- Sharp drill point for quick installation into metal framing
- Extra deep star drive recess to prevent cam-out
- Undercut head to cut cleanly through the hard outer layer of capstock decking
- Available in a variety of colors

### INSTALLATION

- Install flush with decking surface. Do not overdrive.
- Install two screws per joist with a minimum three threads beyond metal framing.
- Predrilling is recommended when fastening within 1" from the end of a deck board. Predrill decking only, not joist.

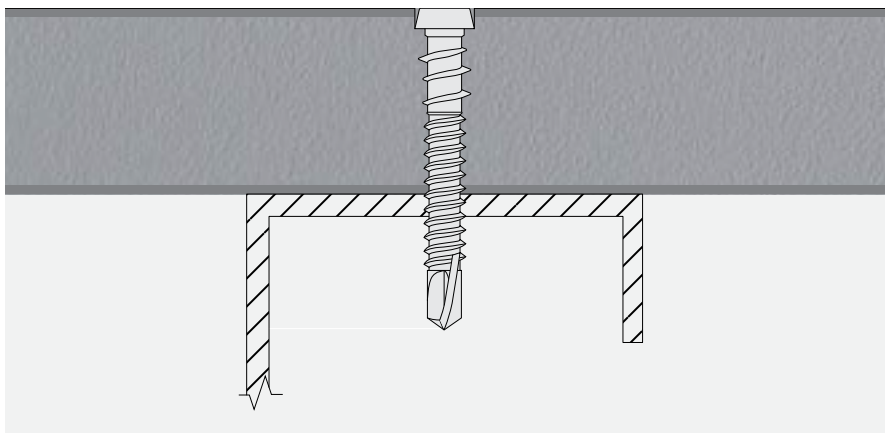

### FINISH

Epoxy coated

### CORROSION

Exterior use—Approved for use in ACQ and pressure treated lumber.

For salt water or other areas where corrosion is a concern, use Grade 316 Cap-Tor xd fasteners with wood sleeper system.

### DRIVE SYSTEM

Star drive

**CAP-TOR® xd Metal**

**AVAILABLE COLORS**

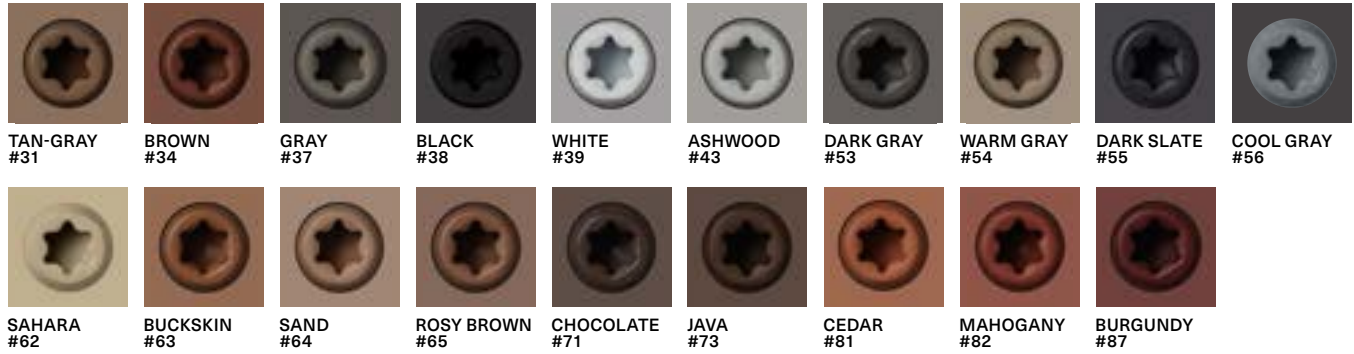

**CAP-TOR® XD METAL COLORS**

LENGTH	FINISH	AVAILABLE COLORS
10 x 1-1/2"	410 Stainless	34, 37, 53, 54, 55, 62, 64, 71, 73, 81, 87
10 x 1-5/8"		31, 34, 38, 37, 39, 43, 53, 54, 55, 56, 62, 63, 64, 65, 71, 73, 81, 82, 87
12 x 2-3/8"		34, 37, 39, 53, 54, 64, 65, 71, 73, 81



**CAP-TOR® XD METAL PACKAGING**

LENGTH	FINISH	DRIVE TYPE	COUNT PACKAGING			
			RETAIL PACK	DECK PACK	PRO PACK	BULK
1-1/2"	410 Stainless	T20	100	350	1750	3500
1-5/8"			100	350	1750	3500
2-3/8"			75	265	1750	—

**BUILDEX® TEKS SELECT™**



5/16" Hex Washer Head: 10–16 x 3/4"

For all steel-to-steel and bracket connections.

Teks Select™ is a trademark of ITW Buildex® and Illinois Tool Works, Inc. Teks Select™ is manufactured by ITW Buildex® and packaged and distributed by Starborn Industries.

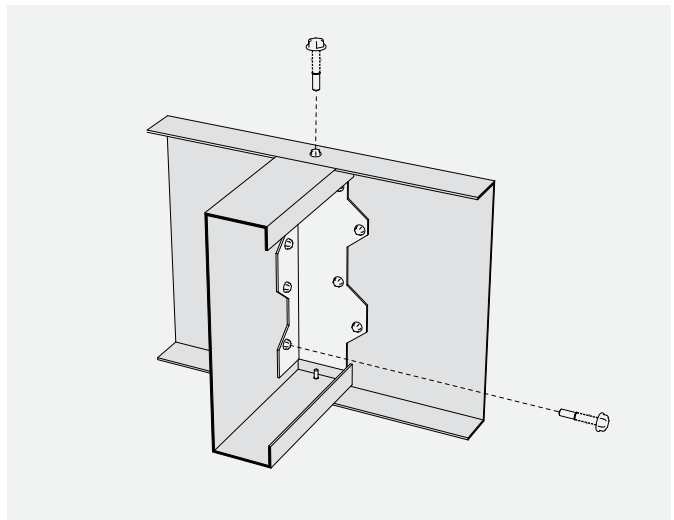

# FASCIA SYSTEM

## Epoxy/Stainless

### Fascia Screw



#### APPLICATION

Color matched fastening system for composite/PVC deck fascia and cladding. The system securely fastens fascia material while also allowing boards to expand and contract freely. Installation is a two-step process utilizing a pre-drilling tool and screws.

#### FEATURES

- Designed for use with 1/2" to 3/4" composite fascia profiles
- Fascia Tool creates an over-sized hole so that the board can expand and contract freely and provides a pre-set countersink that matches the head diameter and depth of the Fascia Screw
- Free spinning collar on Fascia Tool prevents damage to the fascia board surface
- Type 17 auger tips for faster, easier insertion and to help prevent splitting
- Available in a variety of colors

#### INSTALLATION

Follow all fascia manufacturer instructions, including specifications for screw spacing, edge/ end distances, and gapping.

- Pre-drill with the Fascia Tool until the collar stops spinning.
- Drive the Fascia Screw until snug, do not overtighten. The material should hang from the screw to allow for expansion and contraction.

#### FINISH

Epoxy coated  
Grade 305 Stainless

#### CORROSION

Exterior use—Approved for use in ACQ and pressure treated lumber.

For salt water or other areas where corrosion is a concern, use Grade 316 Stainless.

#### DRIVE SYSTEM

Star drive

#### TOOL COMPATIBILITY

Fascia Tool

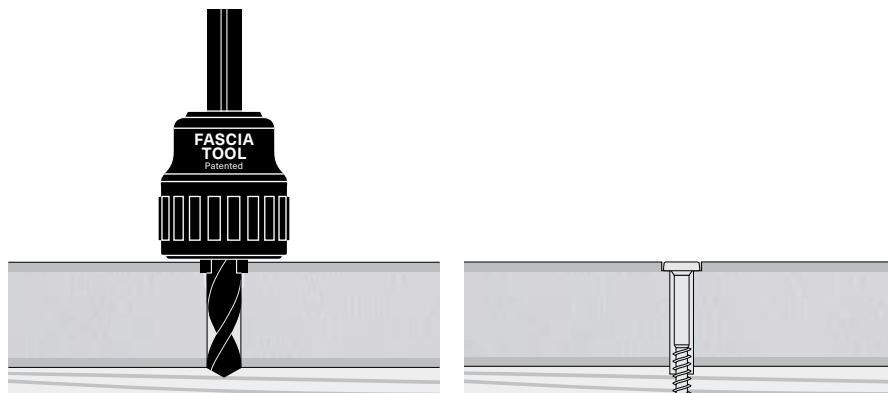

**FASCIA SYSTEM** Epoxy/Stainless

**AVAILABLE COLORS**



**FASCIA SYSTEM COLORS**

LENGTH		AVAILABLE COLORS
10 x 1-7/8"	Epoxy	31, 34, 37, 39, 43, 53, 54, 55, 56, 62, 63, 64, 65, 71, 73, 81, 82, 87
9 x 1-7/8"	305 Stainless	

**SYSTEM COMPONENTS (SOLD SEPARATELY)**



**Fascia Tool**  
Pre-drilling and countersinking

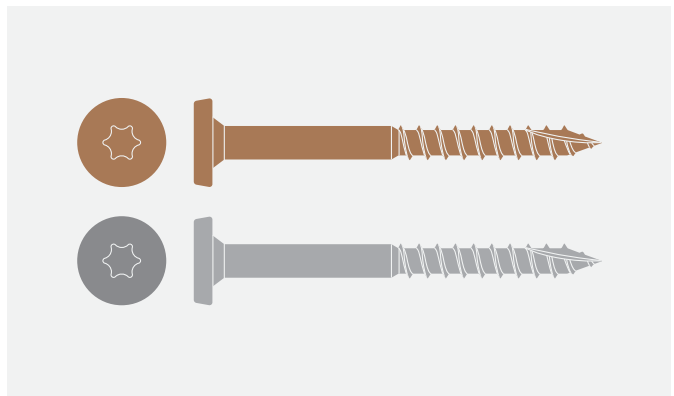

**Fascia Screws**  
Color matched screws available in  
Epoxy Coated or Grade 305 Stainless

**FASCIA SYSTEM PACKAGING**



LENGTH	FINISH	DRIVE TYPE	COUNT PACKAGING	
			RETAIL PACK	BULK
1-7/8"	Epoxy	T20	100	2500
	305 Stainless			

# PRO PLUG SYSTEM<sup>®</sup>

## Deck

Hidden Fastener For PVC/  
Composite Decking and Cladding

Patented

### APPLICATION

Hidden fastening system that provides a secure face-fastened connection with precision cut plugs made from actual decking and cladding materials. Installation is a two-step process utilizing a setting tool, screws and plugs. All components must be used together as instructed to ensure proper function.

### FEATURES

- Plugs are for 1" nominal (or greater) material and available in all leading deck and cladding brands
- Available in Kits (screws, plugs and tool) and Inventory Management (system components sold separately)
- Patented PVC/Composite Tool with Auto-Stop™ sets screw to the correct depth without stripping screw recess
- Free spinning stop collar on setting tool prevents damage to the board surface
- Screws feature a Type 17 auger tip for faster, easier insertion and to help prevent splitting

### INSTALLATION

Follow all decking and cladding manufacturer instructions, including specifications for screw spacing, edge/end distances, and gapping. Predrilling is recommended for all composite deck boards. Predrill a 3/16" pilot hole through the decking material only; not the joist. For Armadillo®, DuraLife®, NewTechWood® and Sylvanix® decking, use a 7/32" pilot hole.

- Fit setting tool with application specific driver bit, marked "DECK".
- Drive the screw with the PVC/Composite Tool using a standard drill on high speed.
- Do not use impact driver with setting tool.
- The setting tool's Auto-Stop™ mechanism will make a "pop" sound when the screw is set to the correct depth. (Do not hesitate or slow down while driving.)
- Insert plug into hole and tap with a smooth-faced hammer until the plug is flush with board.

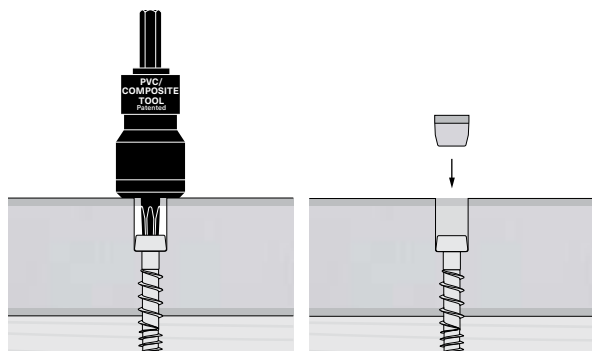

### FINISH

Epoxy coated  
Grade 305 Stainless  
Grade 316 Stainless

### CORROSION

Exterior use—Approved for use in ACQ and pressure treated lumber.  
  
For salt water or other areas where corrosion is a concern, use Grade 316 Stainless.

### DRIVE SYSTEM

Star drive

### TOOL COMPATIBILITY

PVC/Composite Tool  
PVC/Composite DECK Bits



**PLUGS AVAILABLE IN THE FOLLOWING BRANDS**

AERATIS®	AMERICAN PRO	ARMADILLO®	CLUBHOUSE®	DEKORATORS®
DURALIFE®	ENDECK®	ENVISION®	EVA-LAST®	FIBERON®
MOISTURESHIELD®	NEWTECHWOOD®	SYLVANIX®	TIMBERTECH®	TIVA®
TREX®	TRUNORTH DECK®	VEKADECK®	WEARDECK®	WOLF

New board brands are always being added to our product offering. Please refer to our website or contact Starborn® customer service if you do not see the board brand you are looking to use on your project.

**SYSTEM COMPONENTS**

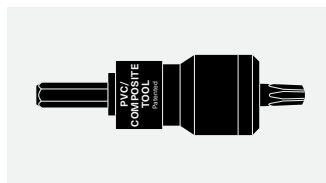

**PVC/Composite Tool**  
For setting screws to the correct depth

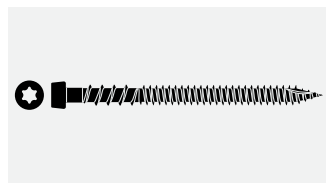

**Screws**  
Epoxy coated, grade 305 or grade 316 stainless, or epoxy coated grade 410 stainless for metal framing

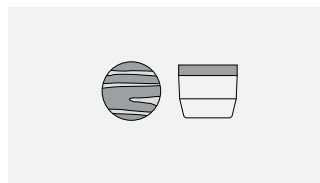

**Plugs**  
Made from actual PVC/Composite decking and trim material

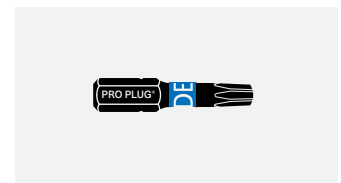

**Deck Bits**

**PRO PLUG® SYSTEM DECK PACKAGING**

KIT PACKAGING					
LENGTH	FINISH	COVERAGE	SCREWS	PLUGS	TOOL
2-3/4"	Epoxy	100 lf	150	165	1
		100 sq ft	350	375	1
		300 sq ft	1050	1125	1
2-1/2"	305 Stainless	100 lf	150	165	1
		100 sq ft	350	375	1
		300 sq ft	1050	1125	1

INVENTORY MANAGEMENT—PLUGS ONLY	
PLUGS	COVERAGE
100	—
375	100 sq ft
1125	300 sq ft

FOR METAL FRAMING—CAP-TOR XD METAL			
LENGTH	FINISH	SCREWS	COVERAGE
1-1/2"	Epoxy Coated 410 Stainless (Metal Framing)	375	100 sq ft
1-5/8"			

**For Metal Framing**  
Use 1-1/2" or 1-5/8" CAP-TOR® xd Metal screw and purchase plugs and PVC/Composite Tool separately.

INVENTORY MANAGEMENT—SCREWS ONLY			
LENGTH	FINISH	SCREWS	COVERAGE
2"	Epoxy	100	—
		375	100 sq ft
		1125	300 sq ft
2-3/4"		100	—
		375	100 sq ft
		1125	300 sq ft
3"		100	—
		375	100 sq ft
		1125	300 sq ft
2"	305 Stainless	100	—
		375	100 sq ft
		1125	300 sq ft
2-1/2"		100	—
		375	100 sq ft
		1125	300 sq ft
3"		100	—
		375	100 sq ft
		1125	300 sq ft
2-1/2"	316 Stainless	100	—
		375	100 sq ft
		1125	300 sq ft
3"		100	—
		375	100 sq ft
		1125	300 sq ft

# PRO PLUG SYSTEM®

## Trim

### Hidden Fastener for PVC Trim Board



#### APPLICATION

Hidden fastening system that provides a secure face-fastened connection with precision cut plugs made from actual PVC trim boards. Installation is a two-step process utilizing a setting tool, screws and plugs. All components must be used together as instructed to ensure proper function.

#### FEATURES

- Plugs are for 5/8" to 1-1/4" thick PVC trim and available in all leading brands
- Available in Kits (screws, plugs and tool) and Inventory Management (system components sold separately)
- Patented PVC/Composite Tool with Auto-Stop™ sets screw to the correct depth without stripping screw recess
- Free spinning stop collar on setting tool prevents damage to the board surface
- Screws feature a Type 17 auger tip for faster, easier insertion and to help prevent splitting

#### INSTALLATION

Follow all PVC trim manufacturer instructions, including specifications for screw spacing, edge/end distances, and gapping.

- Fit setting tool with application specific driver bit, marked "TRIM".
- Drive the screw with the PVC/Composite Tool using a standard drill on high speed.
- Do not use impact driver with setting tool.
- The setting tool's Auto-Stop™ mechanism will make a "pop" sound when the screw is set to the correct depth. (Do not hesitate or slow down while driving.)
- Insert plug into hole and tap with a smooth-faced hammer until the plug is flush with board.

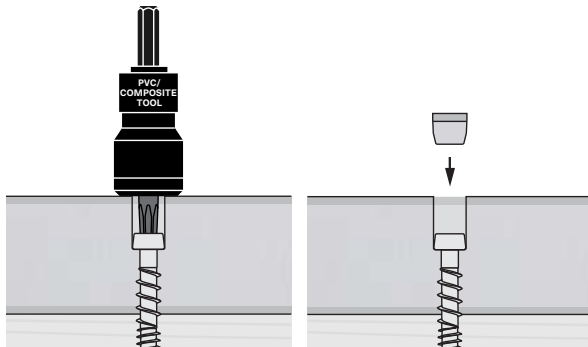

#### FINISH

Epoxy coated  
Grade 305 Stainless  
Grade 316 Stainless

#### CORROSION

Exterior use—Approved for use in ACQ and pressure treated lumber.  
  
For salt water or other areas where corrosion is a concern, use Grade 316 Stainless.

#### DRIVE SYSTEM

Star drive

#### TOOL COMPATIBILITY

PVC/Composite Tool  
PVC/Composite TRIM Bits

**PLUGS AVAILABLE IN THE FOLLOWING BRANDS**

AZEK®	BETTER BRAND®	BORAL®	CERTATRIM®	GREEN ATLANTIC®
INTEPLAST®	KLEER®	KOMA®	PALIGHT®	PLY GEM®
RESTORATION MILLWORK®	ROYAL®	VERSATEX®	WOLF	XO™

New board brands are always being added to our product offering. Please refer to our website or contact Starborn® customer service if you do not see the board brand you are looking to use on your project.

**SYSTEM COMPONENTS**

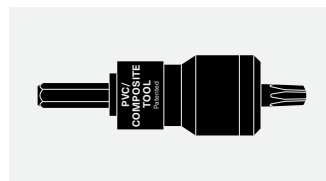

**PVC/Composite Tool**  
For setting screws to the correct depth

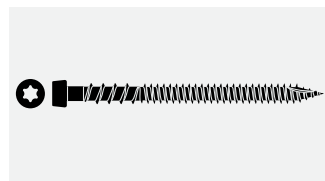

**Screws**  
Epoxy coated, grade 305 or grade 316 stainless, or epoxy coated grade 410 stainless for metal framing

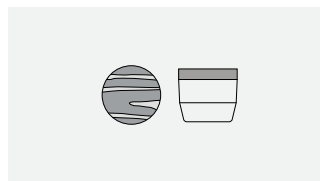

**Plugs**  
Made from actual PVC/Composite decking and trim material

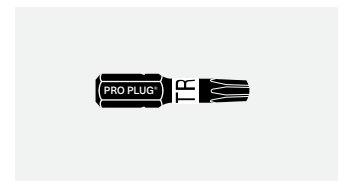

**Trim Bits**

**PRO PLUG® SYSTEM TRIM PACKAGING**

KIT PACKAGING					
LENGTH	FINISH	COVERAGE	SCREWS	PLUGS	TOOL
2"	Epoxy	50 lf	75	85	—
		250 lf	375	400	1
		750 lf	1125	1200	1
2-3/4"		50 lf	75	85	—
		250 lf	375	400	1
		750 lf	1125	1200	1
2"	305 Stainless	50 lf	75	85	—
		250 lf	375	400	1
		750 lf	1125	1200	1
2-1/2"		50 lf	75	85	—
		250 lf	375	400	1
		750 lf	1125	1200	1

INVENTORY MANAGEMENT—SCREWS ONLY				
LENGTH	FINISH	SCREWS	COVERAGE	
2"	Epoxy	100	—	
		375	100 sq ft	
		1125	300 sq ft	
2-3/4"		100	—	
		375	100 sq ft	
		1125	300 sq ft	
3"		100	—	
		375	100 sq ft	
		1125	300 sq ft	
2"		305 Stainless	100	—
			375	100 sq ft
			1125	300 sq ft
2-1/2"	100		—	
	375		100 sq ft	
	1125		300 sq ft	
3"	100		—	
	375		100 sq ft	
	1125		300 sq ft	
2-1/2"	316 Stainless		100	—
			375	100 sq ft
			1125	300 sq ft
3"		100	—	
		375	100 sq ft	
		1125	300 sq ft	

INVENTORY MANAGEMENT—PLUGS ONLY	
PLUGS	COVERAGE
100	—
400	250 lf
1200	750 lf

# PRO PLUG<sup>®</sup> SYSTEM

## Fascia

### Hidden Fastener for Composite Fascia Board and Cladding



#### APPLICATION

Hidden fastening system that securely fastens deck fascia and cladding while also allowing boards to expand and contract freely. Precision cut plugs are made from actual fascia material. Installation is a three-step process utilizing a predrilling tool and a setting tool (sold as a tool set) and screws and plugs. All components must be used together as instructed to ensure proper function.

#### FEATURES

- Fascia Plug Tool predrills an over-sized hole so that the board can expand and contract freely and provides a pre-set countersink that matches the diameter and depth of screw and plug
- Free spinning stop collar on Fascia Plug Tool prevents damage to the board surface
- PVC/Composite Tool with Fascia Bit sets screw to proper depth and eliminates overdriving screw
- Screws feature Type 17 auger tip for faster, easier insertion and to help prevent splitting
- Kit packaging includes screws and plugs (Fascia Plug Tool Set sold separately)

#### INSTALLATION

Follow all fascia manufacturer instructions, including specifications for screw spacing, edge/ end distances, and gapping.

- Fit setting tool with application specific driver bit, marked "FSCA".
- Predrill with the Fascia Plug Tool until the collar stops spinning.
- Drive the screw with the PVC/Composite Tool using a standard drill on high speed.
- Do not use impact driver with setting tool.
- The setting tool's Auto-Stop™ mechanism will make a "pop" sound when the screw is set to the correct depth. (Do not hesitate or slow down while driving.)
- Insert plug into hole and tap with a smooth-faced hammer until the plug is flush with board.

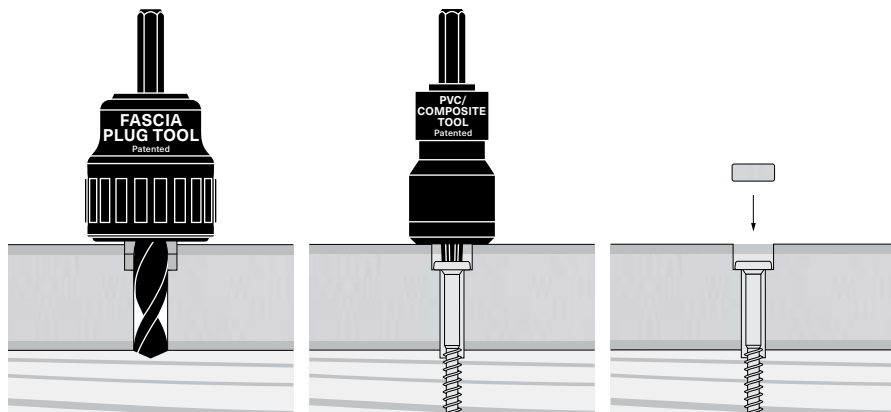

#### FINISH

Epoxy coated  
Grade 305 Stainless  
Grade 316 Stainless

#### CORROSION

Exterior use—Approved for use in ACQ and pressure treated lumber.  
  
For salt water or other areas where corrosion is a concern, use Grade 316 Stainless.

#### DRIVE SYSTEM

Star drive

#### TOOL COMPATIBILITY

Fascia Plug Tool Set

**PLUGS AVAILABLE IN THE FOLLOWING BRANDS**



New board brands are always being added to our product offering. Please refer to our website or contact Starborn® customer service if you do not see the board brand you are looking to use on your project.

**SYSTEM COMPONENTS**

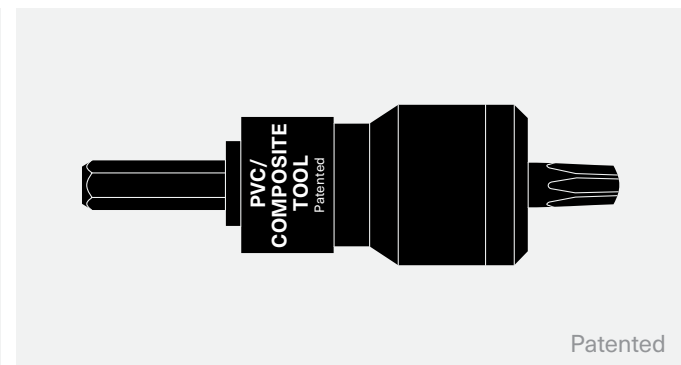
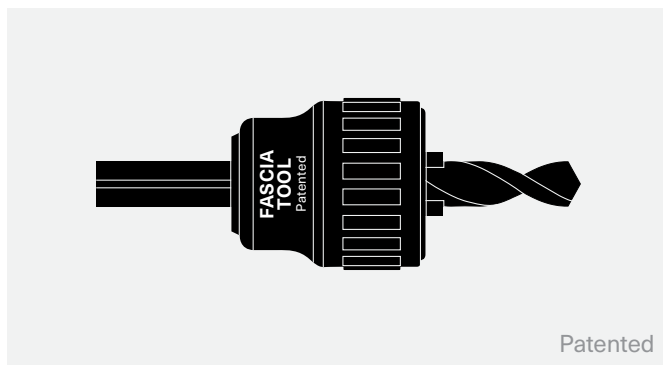

**Fascia Plug Tool Set**

Fascia Plug Tool for pre-drilling and PVC/Composite Tool for screw setting. (Sold Separately)

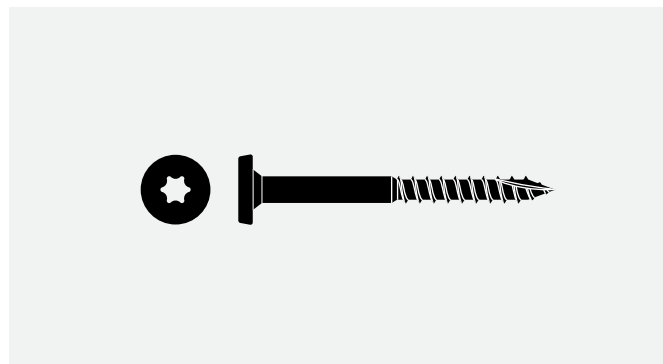

**Fascia Screws**

Epoxy coated, grade 305 or grade 316 stainless

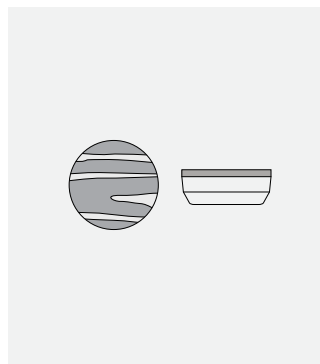

**Fascia Plugs**

Made from actual fascia material to match perfectly

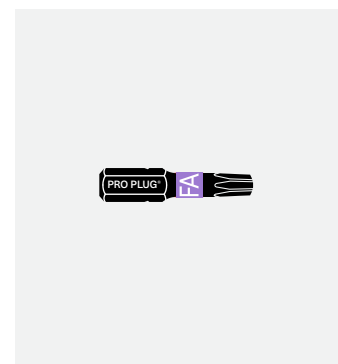

**Fascia Bit**

**PRO PLUG® SYSTEM FASCIA PACKAGING**

LENGTH	FINISH	DRIVE TYPE	KIT PACKAGING		
			SCREWS	PLUGS	TOOL
1-7/8"	Epoxy	T20	100	100	—
	305 Stainless				
	316 Stainless				

# PRO PLUG SYSTEM®

## Wood

### Hidden Fastener for Wood Decking and Flooring



#### APPLICATION

Hidden fastening system that provides a secure face-fastened connection with precision cut, face grain plugs made from a variety of hardwood decking and flooring. Installation is a four step process utilizing a predrilling tool, glue (sold separately), screw and plug.

#### FEATURES

- Provides the strength of top-down fastening with the high end finish of face grain wood plugs
- Drill, screw, glue and plug all types of hardwoods in a fraction of the time compared to traditional plug methods
- Patented Wood Tool creates a screw hole, countersink and counterbore to match other system components
- Free spinning stop collar on Wood Tool prevents damage to the board surface
- Patented glue nozzle applies glue to the sidewall of the counterbored hole
- Kit packaging includes screws, plugs and glue nozzle (Wood Tool sold separately)

#### INSTALLATION

Follow all decking and flooring manufacturer instructions, including specifications for screw spacing, edge/end distances, and gapping.

- Predrill with the countersinking Wood Tool using a corded drill on high speed until the collar stops spinning. Remove debris from hole.
- Drive screw so that it is fully seated in the countersink. (Do not overtighten.)
- Fit glue nozzle on glue bottle. Apply glue to hole by pushing down and gently squeezing the bottle while rotating it one quarter turn, then remove. Glue should coat the side walls of the hole.
- Insert plug into hole, align grain of plug to match grain of board, and tap with a smooth-faced hammer until the plug is flush with board.

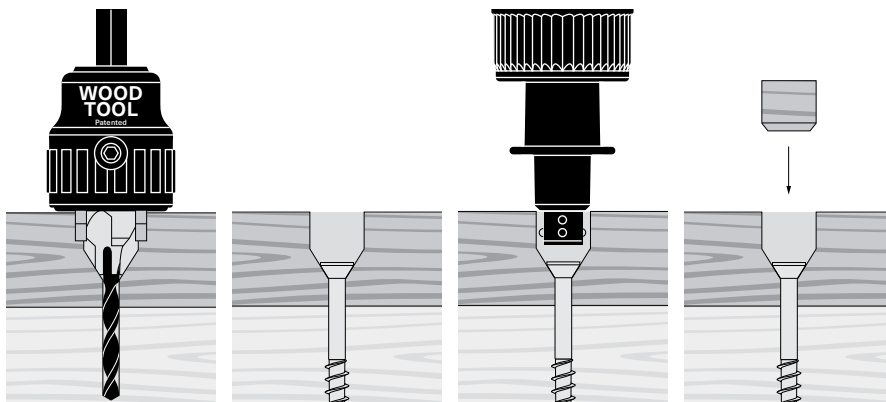

<b>FINISH</b>
<b>DECKING KITS</b>
Grade 305 Stainless Grade 316 Stainless
<b>FLOORING KITS</b>
Grade 305 Stainless
<b>CORROSION</b>
<b>DECKING &amp; FLOORING KITS</b>
Exterior use—Approved for use in ACQ and pressure treated lumber.  For salt water or other areas where corrosion is a concern, use Grade 316 Stainless.
<b>DRIVE SYSTEM</b>
Star drive
<b>TOOL COMPATIBILITY</b>
Wood Tool Wood Tool Replacement Bits



**PLUGS AVAILABLE IN THE FOLLOWING HARDWOOD DECKING**

ALASKAN YELLOW CEDAR	BAMBOO	CAMBARA	CUMARU	DASSOXTR FUSED BAMBOO®
GARAPA	IPE	IRON WOODS®	JATOBA	KEBONY®
MAHOGANY	MASSARANDUBA	MERANTI	MERBAU	PEDRA
PROTEAK	RED BALAU	THERMORY®	TIGERWOOD	YELLOW BALAU

**PLUGS AVAILABLE IN THE FOLLOWING HARDWOOD FLOORING**

AMERICAN CHERRY	AMERICAN WALNUT	EASTERN WHITE PINE	MAHOGANY	POPLAR
RED OAK	WHITE OAK			

New board brands are always being added to our product offering. Please refer to our website or contact Starborn® customer service if you do not see the board brand you are looking to use on your project.

**SYSTEM COMPONENTS**

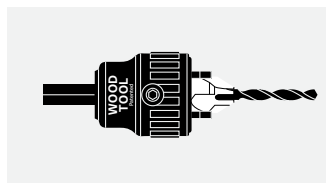

**Countersinking Wood Tool**  
For predrilling and countersink  
(Sold separately)

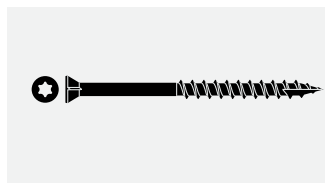

**Screws**  
Grade 305 or Grade 316  
stainless for decking, Grade  
305 stainless for flooring

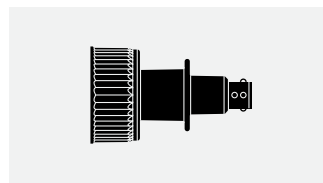

**Glue Nozzle**  
Applies glue to sidewalls of  
screw hole

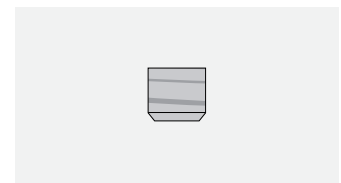

**Plugs**  
Made from actual hardwood  
species

**PRO PLUG® SYSTEM WOOD PACKAGING**

DECK KIT PACKAGING					
LENGTH	FINISH	COVERAGE	SCREWS	PLUGS	TOOL
1-5/8"	305 Stainless	25 sq ft	100	100	—
		100 sq ft	350	350	—
		300 sq ft	1050	1050	—
2-1/2"		25 sq ft	100	100	—
		100 sq ft	350	350	—
		300 sq ft	1050	1050	—
1-5/8"	316 Stainless	25 sq ft	100	100	—
		100 sq ft	350	350	—
		300 sq ft	1050	1050	—
2-1/2"		25 sq ft	100	100	—
		100 sq ft	350	350	—
		300 sq ft	1050	1050	—

FLOOR KIT PACKAGING					
LENGTH	FINISH	COVERAGE	SCREWS	PLUGS	TOOL
1-5/8"	305 Stainless	25 sq ft	100	100	—
		100 sq ft	350	350	—
		300 sq ft	1050	1050	—

# SMART-BIT®

## Predrilling and Countersinking Tool

For use with HEADCOTE®  
and DECKFAST® Stainless Screws

Patented

### APPLICATION

Designed for decking and general woodworking when materials require predrilling. Tools are engineered to match precisely with HEADCOTE® and DECKFAST® stainless steel screws to provide a clean and professional finish.

### FEATURES

- Perfect for use with hardwoods like ipe, mahogany, meranti and merbau
- Pre-set countersink matches head shape of HEADCOTE® and DECKFAST® stainless steel screws
- Free spinning stop collar protects board surface
- Durable ball bearing assembly
- Replaceable Powerbolic® fluted drill bits that cut through decking more than twice as fast as standard wood bits

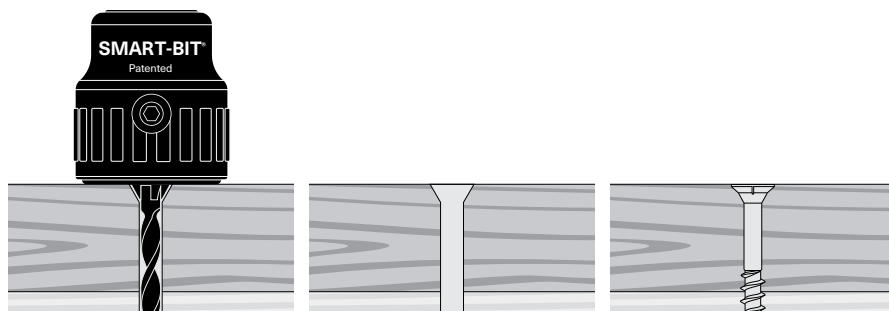

### CORRECT USE

- Choose the tool size gauge that matches the diameter and head style of screw.
- (The 1-1/8" overall hole depth is sufficient for installing decking material up to 5/4 nominal (30mm thick))
- Drill in a straight and stable fashion.
- The hole is complete when the collar stops spinning.

### REPLACING BITS

- Disconnect power and remove the SMART-BIT® Tool from the drill.
- Loosen the set screw with the included hex wrench.
- Remove old bit and insert a new bit fully into the countersink portion with the flat side facing the set screw.
- Tighten the set screw.
- Use only SMART-BIT® Powerbolic® replacement bits.

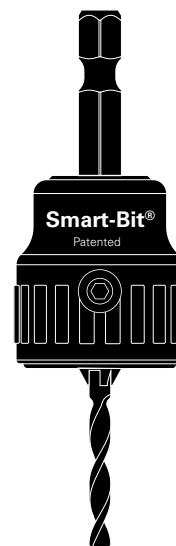

**DIMENSIONS**

TOOL SIZE GAUGE (MM)	HEAD STYLE	DRILL BIT MM (INCH)	COUNTERSINK DIA. MM (INCH)	COUNTERSINK ANGLE	HOLE DEPTH* MM (INCH)
#7 (4.2)	Trim	3.0 (7/64")	6.2 (1/4")	60°	30 (11/8")
#8 (4.5)	Trim	3.2 (1/8")	6.6 (17/64")	60°	30 (11/8")
#8 (4.5)	Flat	3.2 (1/8")	8.4 (21/64")	82°	30 (1-1/8")
#10 (5.0)	Flat	3.6 (9/64")	9.2 (23/64")	90°	30 (11/8")
#12 (5.5)	Flat	4.0 (5/32")	11 (7/16")	82°	40 (19/16")
#14 (6.2)**	Flat	5.25 (13/64")	12.9 (1/2")	82°	40&75 (19/16"&3")

\*Overall hole depth including countersink portion. When installing decking it is general practice to not pre-drill the underlying (joist) material; this is usually treated lumber and does not require pre-drilling. The 11/8" overall hole depth is sufficient for installing decking material up to 5/4 thick (nominal).

\*\*The #14 Smart-Bit® comes with two 40mm bits and one 75mm bit. Durable ball bearing assembly

**ALSO AVAILABLE FOR FIBER CEMENT**

Designed specifically for use with compressed fiber cement board, but can also be used with a variety of fiber cement and masonry products.

- Tungsten carbide tip
- Durable ball bearing assembly
- Free spinning stop collar
- Use with #10 (5.0mm) flat head screws

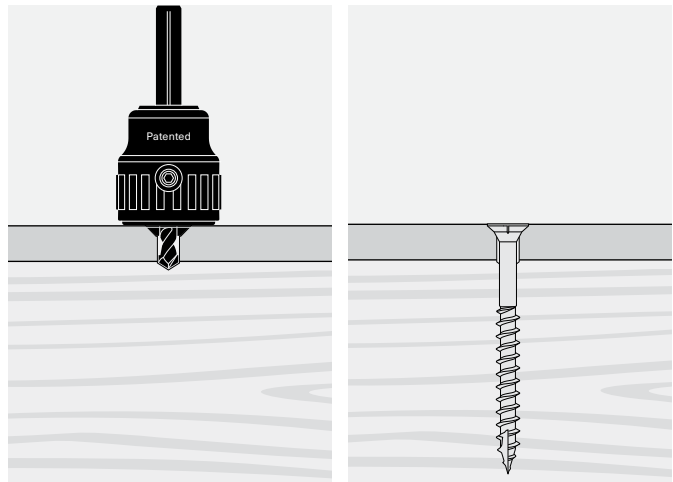

# SMART-BIT®

## Depth Setter Tool

Driving Tool for Setting Screws to the Perfect Depth

Patented

### APPLICATION

Designed to drive screws to the perfect depth—flush or below the work surface—every time. Adjustable and easy to use on decks, drywall and in general construction. The tool works with Phillips® and Torx® bits and is designed for use with Starborn® fasteners and other screw products.

### FEATURES

- Perfectly set screws every time
- Locking rings allow for screw depth adjustment and secures desired setting for consistent screw installation
- Auto-Stop™ mechanism sets screw to the correct depth without stripping screw recess
- Free spinning stop collar prevents damage to the board surface

### CORRECT USE

- Use a standard drill. Do not use an impact driver.
- Drill in a straight and stable fashion.
- The screw is set when the Auto-Stop™ mechanism engages fully (making a “pop” sound in most materials).

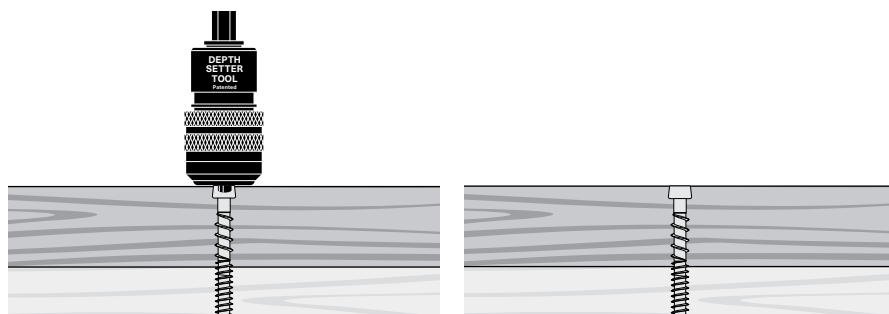

### REPLACING BITS

- Disconnect power and remove the SMART-BIT® Tool from the drill.
- Loosen the set screw with the included hex wrench.
- Remove old bit and insert a new bit fully into the countersink portion with the flat side facing the set screw.
- Tighten the set screw.
- Use only SMART-BIT® Powerbolic® replacement bits.

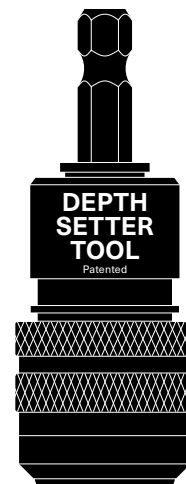

**SMART-BIT®** Depth Setter Tool

**COMPATIBLE STARBORN® SCREWS**

**CAP-TOR® xd Stainless**

Color Matched Screws for PVC and Composite Decking

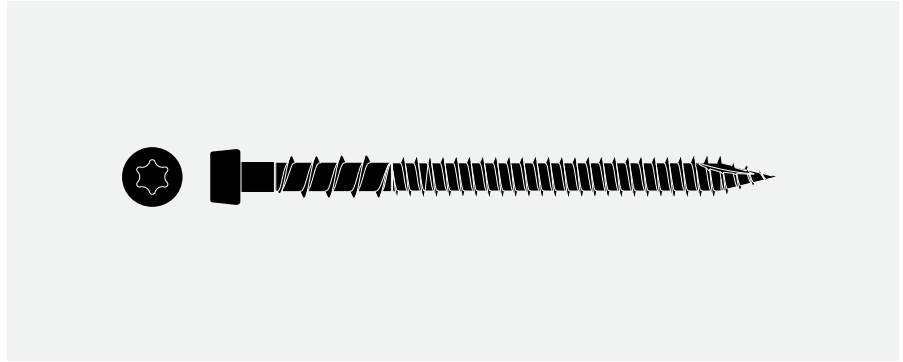

**DECKFAST® Epoxy**

Lumber and PVC Trim

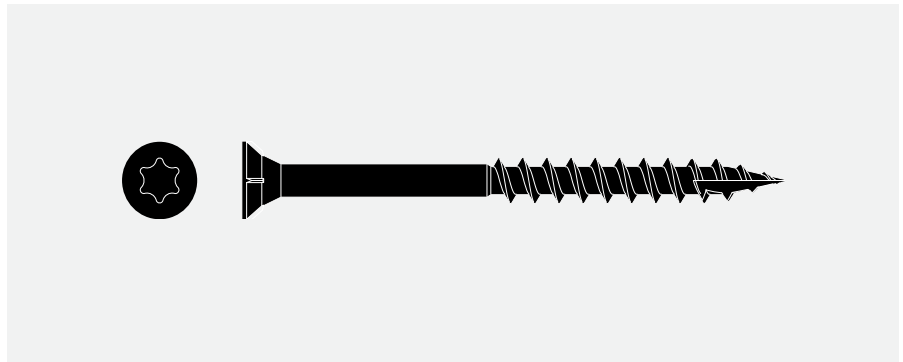

**CAP-TOR® Metal**

Color Matched Screws for Fastening PVC, Composite and Hardwood Decking to Trex Elevations and other Metal Framing Systems

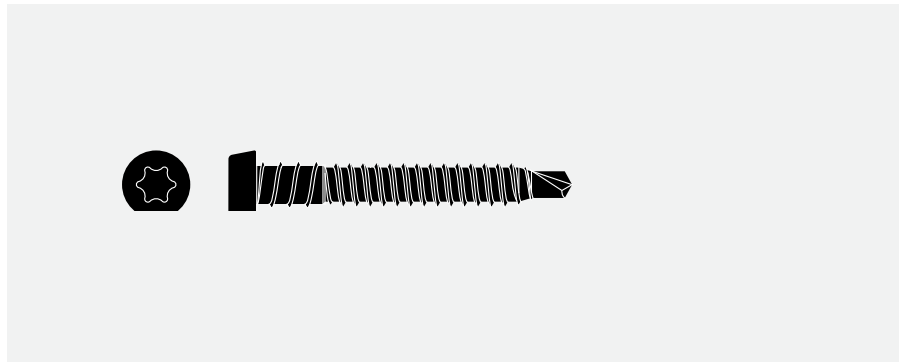

# STARBORN DECKMATCHER TABLE

STARBORN COLOR	ARMADILLO	CLUBHOUSE	DECORATORS	DURALIFE	ENDECK	ENVISION	EVA-LAST	FIBERON	
TAN-GRAY #31	CAMPFIRE • FIREWOOD • MESA • PAINTED DESERT	COBBLESTONE	COASTLAND • COSTA • HICKORY	MAHOGANY • TROPICAL WALNUT	CEDAR • SABLE	WEATHERED WOOD SPICED TEAK • TANTRIDGE OAK • VINTAGE OAK	ALASKAN DRIFTWOOD • CAPE TOWN GREY • CONCRETE GRAY	CABIN • IPE • JATORA • MORINGA • MARI • TULIP • TUDOR BROWN • DUNE • SUMAC • WILLOW	
BROWN #34	CONVOY	HICKORY	ASHWOOD • COMPASS GRAY • FIELDSTONE • GRAY • KETTLE • SALTWATER • SILVERWOOD • SUMMIT	IRONSTONE	SLATE	ALPINE FOG • CAPE COD GREY • NANTUCKET SHORE	CARRIBBEAN CORAL • GRAY SLATE • SAPPHIRE SILVER • CARBONIZED OSAGE • CHARRED CEDAR	CASTLE GRAY • COTTAGE • MINERAL • MORA • NANTUCKET GRAY • SEASIDE MIST	
GRAY #37									
BLACK #38									
WHITE #39	LINEN • WHITE SAND		MACADAMIA						
ASHWOOD #43		SANDSTONE							
IVORY #45									
KHAKI #48									
DARK GRAY #53	CANYON GRAY • SMOKE • STEEL WOOL • THUNDER	DRIFTWOOD	DUSK • LAKEVIEW • RIDGELINE • RIDGEWAY • SIERRA • SMOKEHOUSE	ARCADIA GRAY • GARAPA GREY • SLATE	DAWN	GREY WOOD • HARBOR GREY	ALASKAN DRIFTWOOD • CAPE TOWN GREY • CONCRETE GRAY	BEACH HOUSE • FLAGSTONE • GRAPHITE • MOONLIGHT COVE • PALO	
WARM GRAY #54		BROOKSTONE	TUNDRA	COASTAL GREY		BARNWOOD PLANK • GUNSTOCK	ARCTIC BIRCH	CABANA • CHAI • SANDSTONE • SHADED CAY	
DARK SLATE #55	CHARCOAL	IRONWOOD	DRIFTWOOD • SLATE (PICTURE FRAME)				SIBERIAN BARK	EARL GREY • GRAY BIRCH • WEATHERED CLIFF • WENGE	
COOL GRAY #56	DOVETAIL						SWEDISH OAK	BAMBOO • PRAIRIE WHEAT CLAY • TUSCAN VILLA • WARM SIENNA	
SAHARA #62							HIMALAYAN CEDAR		
BUCKSKIN #63							SAHARA SAND • WEATHERED ASH		
SAND #64	SAW GRASS	CLAY	CEDAR • DUNEWOOD • SANDALWOOD • TIMBERLINE	ASPEN TEAK • PEBBLE	DUSK • OLIVEWOOD	HAMPTON DUNE • SANDSTONE • SEASIDE PIER	OASIS PALM	BROWNSTONE	
ROSY BROWN #66							SAHARA SAND • WEATHERED ASH		
CHOCOLATE #71	BOURBON • FOOTHILLS • SALCOON • TWILIGHT • WALNUT	WALNUT	BARREL-AGED OAK • KHAYA • IRONWOOD • PATHWAY • RIVERHOUND • SHIPYARD BROWN	CABO BROWN • MOCHA	CHESTNUT	BLACK WALNUT • RUSTIC WALNUT • WEATHERED WICKER • WOODLAND BARK	BRAZILIAN TEAK • ESPRESSO ROAST • HAWAIIAN WALNUT • HAWAIIAN WALNUT	BURNT UMBER • ESPRESSO • KOA • LATTE	
JAVA #73	BRONCO • TORTOISE • TUMBLEWEED • VINTAGE SLATE	MAHOGANY	CANYON • CHICORY • KINGWOOD • RIVERSIDE • ROSEWOOD • WALNUT • WOODLAND	SEQUOIA	CANYON RIDGE • CARRIBOU BROWN • SHADED AUBURN	SPANISH SAFFRON • TIGER COVE		BUNGALOW • CHESTNUT • MOUNTAIN ASH • ROSEWOOD • SANDY PIER	
CEDAR #81			SEDONA	BRAZILIAN CHERRY • GOLDENTEAK		CEDAR	BARREL OAK • CHESTNUT CEDAR • NATURAL CEDAR • WESTERN RED CEDAR • ISLAND MAHOGANY • NATURAL IPE	TUPELO	
MAHOGANY #82	RUSTIC RED • SUNSET					REDWOOD			
BURGUNDY #87									
STARBORN COLOR	MOISTURESHIELD		SYLVANIX	TIMBERTECH	TEXAS	TRUNORTH	VEKADOCK	WEARBECK™	WOLF
TAN-GRAY #31	EARTHSTONE		MESA BROWN • SANDPOINT • SPANISH CEDAR • TEAK	AUTUMN CHESTNUT • WEATHERED TEAK ANTIGUA GOLD • BROWN OAK • DARK ROAST • DARK TEAK • ENGLISH WALNUT • MAHOGANY • MORADO	HAWAIIAN GOLD • JASPER • CORACOKE • SADDLE • TREE HOUSE	SAND	CAVENNE	WEATHERED IPE AMBERWOOD • CEDAR RIDGE • ROSEWOOD	
BROWN #34	BRIDE • CAJONE • TIGERWOOD • WALNUT			ISLAND OAK • SANDSTORM GRAY • WEATHERED OAK	PEBBLE GREY • ROCKY HARBOR • WHIBBEY	HAZELWOOD • STONE GREY	STORM	GRAY	DRIFTWOOD GREY • POTOMAC GREY
GRAY #37	ALPINE GRAY • AURORA MIST • CAPE COD GRAY • CATHEDRAL STONE • CTADEL • LAKE FOG	SUMMIT GREY	ASHWOOD • CASTLE GATE • COASTLINE • DRIFTWOOD • MARITIME GRAY • SEASALT GRAY • SILVER MAPLE • STONE ASH • STORM GRAY	WOOD GRAIN WHITE			WHITE	WHITE	
WHITE #39			BEACHWOOD GRAY • RECLAIMED CHESTNUT • WHITE WHITEWASH CEDAR				GRAY	BARFOOT GRAY	
ASHWOOD #43			HAZELWOOD				ALMOND		
IVORY #45							KHAKI		
OLIVE GRAY #51									
DARK GRAY #53	GRAYSTONE • HARBOR GRAY • SMOKEY GRAY • SOUTHERN BARNWOOD	ASPEN GRAY • GRAPHITE • LAKE GREY • PONDERAY	ISLAND OAK • SANDSTORM GRAY • WEATHERED OAK	CLAM SHELL • ISLAND MIST	AMAZON GREY • ASH GREY		ALMOND	BARFOOT SAND	ALMOND • GOLDEN CYPRESS
WARM GRAY #54	CATALINE • SANDSTONE		BOARDWALK • GREY • SLATE GRAY AMAZON MIST	BISCAYNE • GRAVEL PATH WINCHESTER GREY FOGGY WHARF • RAINIER			MOCHA	SAND	SAND CASTLE • SILVER TEAK • WILLOW CASHMERE
DARK SLATE #55									
COOL SLATE #56									
SAHARA #62									
BUCKSKIN #63	SHORESIDE		SAND DUNE HARVEST BROWN • TROPICAL GOLD	NATURAL WHITE OAK ANTIQUE LEATHER • COCONUT HUSK • TIGERWOOD	CARMEL • ROPE SWING	TIGERWOOD			
SAND #64	DESERT SAND • MOCHACCINO								
ROSY BROWN #66									
CHOCOLATE #71	RIVERBANK • SPANISH LEATHER	MERLOT • VANTAGE		ACACIA • AMERICAN WALNUT • BRAZILIAN WALNUT • DARK COCOA • DARK HICKORY • ESPRESSO • KONA	BEACH DUNE • TOASTED SAND COASTAL BLUFF • VINTAGE LANTERN • WOODLAND BROWN	BRLE	HAZELNUT • WALNUT		BLACK WALNUT • MOCHA
JAVA #73	BRAZILIAN CHESTNUT • COL DREEM • GRAPHITE • KAYAK • ICELANDER • NORTHERN • ROSEWOOD • RUSTIC TIMBER	CHERRYWOOD		ANTIQUE PALM • CARIBBEAN REDWOOD • DARK OAK • RUSTIC ELM • SABLE CYPRESS	FIRE PIT • LAVA ROCK • SPICED RUM • SUNSET COVE	BRAZILIAN CHERRYWOOD • TROPICAL WALNUT CARAMEL	ESPRESSO	CEDAR	CINNAMON TEAKWOOD REDWOOD
CEDAR #81	RUSTIC CEDAR								
MAHOGANY #82									
BURGUNDY #87	SEASONED MAHOGANY				MADERA	RED BORDEAUX			

Visit [starbornindustries.com/deck-matcher](http://starbornindustries.com/deck-matcher) for an interactive version of this chart, which also includes wood decking. The online version is updated frequently with new boards and colors.

Starborn Industries, Inc. Edison, NJ 08837 USA  
Rev. Date: 2024-02